

SERVICING INFORMATION



MODEL 480

CRT TESTER/REJUVENATOR

PARTS LIST 488-321-9-002

SCHMATIC SYMBOL	DESCRIPTION	B & K-PRECISION PART NO.
-----------------	-------------	--------------------------

ELECTROLYTIC CAPACITORS

C1	5 μ F, 250 VDC	021-018-9-001
C2, 3	50 μ F, 450 VDC	021-056-9-001

DIODES

D2	Germanium Diode, 1N67	150-008-9-001
D1, 3-9	Rectifier, 600 PIV, 1 A	151-050-9-001

RESISTORS AND CONTROLS

Standard value resistors are not listed. Values may be obtained from schematic diagram.

R1	3 Ω , \pm 10% Linear, 12-1/2 W, Wire Wound Pot	009-038-9-001
R3	50 k Ω , \pm 10% Linear, 1/2 W, Carbon Pot	008-135-9-001
R6	1 M Ω , \pm 1%, 1/2 W, Metal Film Resistor	011-061-9-001
R7	50 k Ω \pm 30%, Horizontal Mount Linear Trimmer Pot	008-224-9-001
R9	49.9 Ω , \pm 1%, 1/4 W, Metal Film Resistor	011-218-9-001
R10	1 k Ω , \pm 30%, Logarithmic Taper Carbon Pot	008-213-9-001
R11	0.99 Ω , \pm 1%, 1/2 W, W.W. Resistor	004-115-9-001
R13, R14	2.5 k Ω , \pm 10%, 7 W, W.W. Resistor	014-007-6-252
R15	4.7 Ω , \pm 10%, 1/2 W, W.W. Resistor	006-102-9-479
R17 - 19	200 k Ω , \pm 10%, 2 W, Pot	008-819-9-001

SWITCHES

S1	11-Position Rotary Switch (Function)	083-168-9-001
S2	3-Position Rotary Switch (Gun Selector)	083-170-9-001
S3	6-Position Rotary Switch (Htr. Range)	083-091-9-001
S4	Pushbutton Switch 3PDT Momentary	088-026-9-001
(OR)	Pushbutton Switch 4PDT Momentary (ALT. S4)	088-188-9-001

MISCELLANEOUS

F1	Fuse 3/10 A, 250 V, 3 AG Slow-Blow	190-004-0-001
PL1	Neon Bulb, NE-2 with 7" Leads	401-016-9-001
T1	Power and Filament Transformer (120 V)	065-105-9-001
	Power and Filament Transformer (120/240 V)	065-105-9-002

COMPOSITE
499-383-9-001

MISCELLANEOUS (Continued)

M1	Meter	320-061-9-001
	Line Cord (U.S./CSA Version)	420-013-9-001
	Line Cord (Export Version)	420-070-9-001
	Knob, Function	751-353-9-001
	Knob, Small	751-351-9-001
	Knob, Gun Selector and Htr. Range	751-352-9-001
	Knob, Pushbutton Black (S4)	384-016-9-006
	Knob, Pushbutton Black (for ALT. S4)	384-128-9-001
	Lens Cap, Red	750-003-9-001
	Tube Chart	497-022-0-000
	Instruction Manual	480-640-9-001
	Output Cable Assembly	427-013-9-001
	Plastic Insert (For Chassis)	380-627-9-001
	Adaptor Holder Assembly	524-030-9-001
	Foam (For Adaptors)	388-131-9-001
	Case Assembly, Complete	524-031-9-001
	Case Top (ONLY)	271-487-9-001
	Case Bottom (ONLY)	271-488-9-001
	Latch, Case (ONLY) 2 Req'd	754-008-9-001
	Case Nameplate (ONLY)	600-197-9-001

PARTS ORDERING INFORMATION

There is a minimum charge for each invoice. Orders will be shipped C.O.D. unless previous open account arrangements have been made or remittance accompanies order. Advance remittance must cover handling, postage, or express charges. Specify model and serial number when ordering replacement parts.

ORDER REPLACEMENT PARTS FROM:

B & K-Precision
 Factory Service Operations
 6470 West Cortland Street
 Chicago, Illinois 60635
 Telex: 25-3475



BK PRECISION®

6470 W. Cortland St. • Chicago, IL 60635

EXD (EXPORT MODEL)

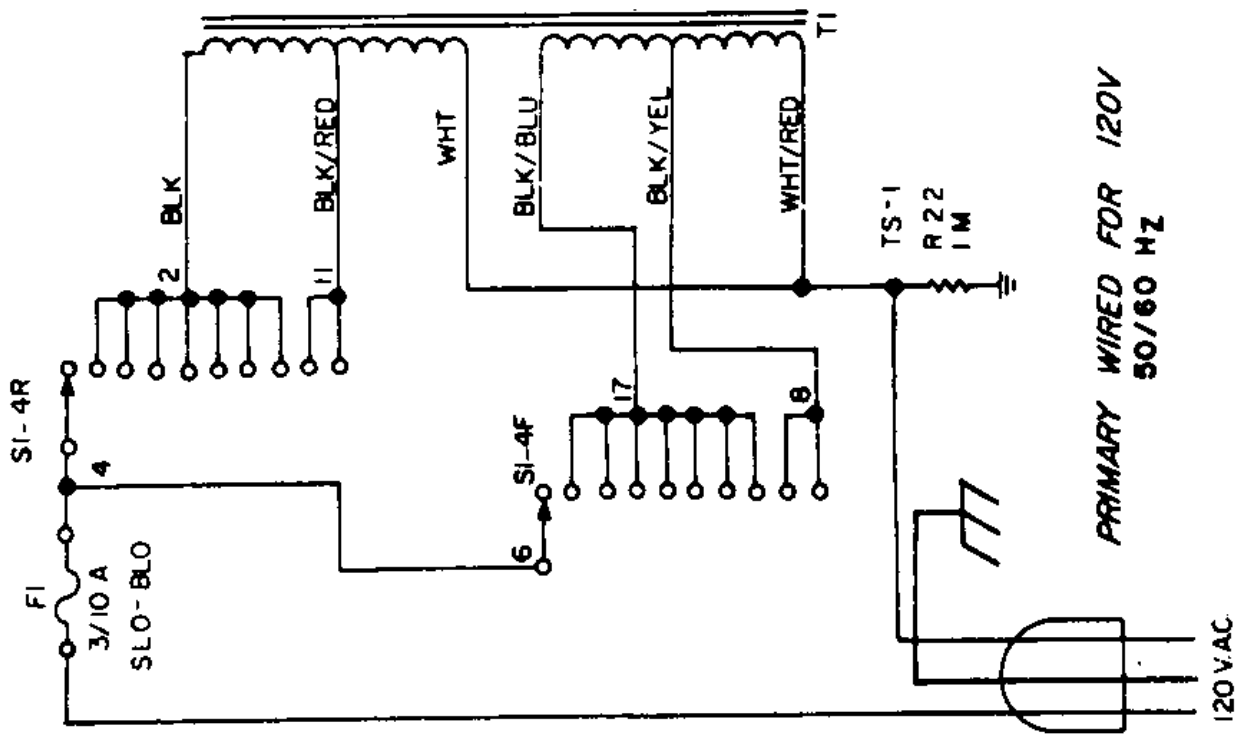
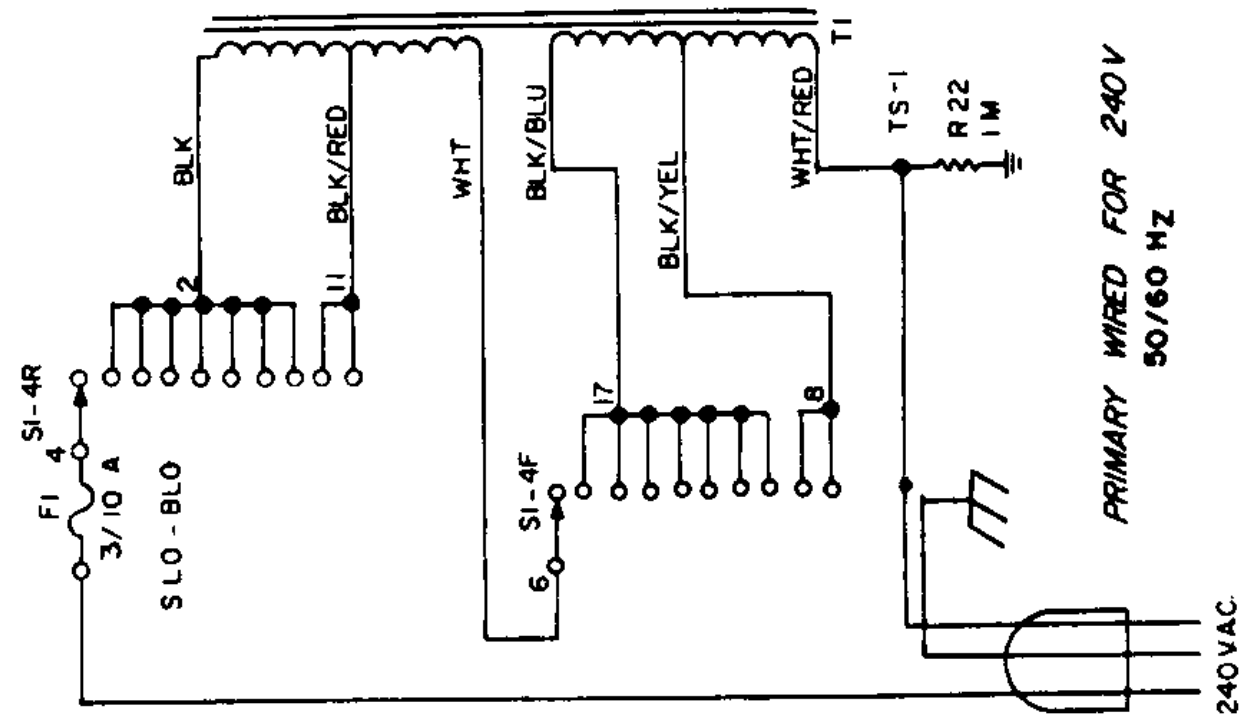

PICTORIAL VIEW OF SWITCH WAFERS

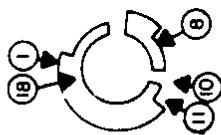

SWITCH 1, 1 FRONT

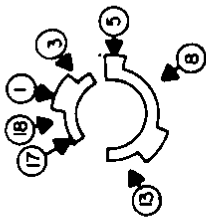

SWITCH 1, 2 FRONT

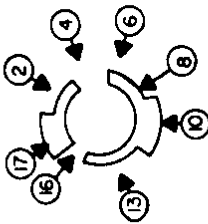

SWITCH 1, 3 FRONT

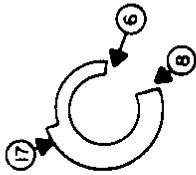

SWITCH 1, 4 FRONT

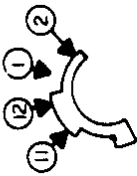

SWITCH 2, 1 FRONT

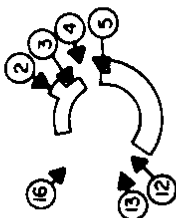

SWITCH 1, 1 REAR

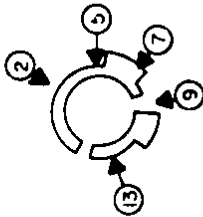

SWITCH 1, 2 REAR

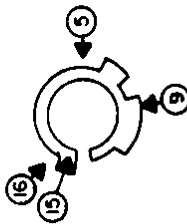

SWITCH 1, 3 REAR

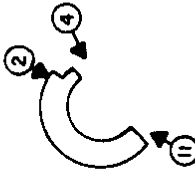

SWITCH 1, 4 REAR

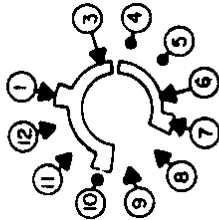

SWITCH 2, 1 REAR

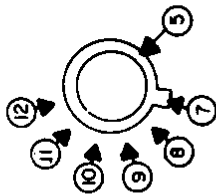

SWITCH 3, 1 REAR

ALL SWITCH WAFERS VIEWED FROM FRONT (KNOB END) WITH SWITCH IN FULL COUNTER-CLOCKWISE POSITION.

OUTPUT CABLE		
WIRE COLOR	FUNCTION	PIN NO.
BLK	HTR	1
BRN	HTR	2
GRY	G ₁ RED	3
TAN	G ₁ GRN	4
PUR	G ₁ BLU	5
RED	K RED	6
GRN	K GRN	7
BLU	K BLU	8
ORG	G ₂ RED	9
YEL	G ₂ GRN	10
PINK	G ₂ BLU	11
WHT	G ₃ / G ₄	12

FUNCTION		FUNCTION
S1=	1	POWER OFF
	2	SET HEATER
	3	HTR LEAKAGE
	4	G ₁ LEAKAGE
	5	SET G ₁ VOLTAGE
	6	SET G ₂ CUTOFF VOLTAGE
	7	READ EMISSION
	8	SET COLOR TRACKING
	9	REMOVE SHORTS
	10	CLEAN • BALANCE
	11	REJUVENATE
S2 =	1	RED / B&W
	2	GREEN
	3	BLUE
S3=	1	0- 4
	2	4- 7
	3	7- 9
	4	8- 11
	5	10- 12
	6	12- 14
S4=		REMOVE SHORTS CLEAN • BALANCE REJUVENATE

NOTES:

UNLESS OTHERWISE SPECIFIED

1 ALL RESISTORS 1/2W, 10%.

2 ALL DIODES 1A, 600V.

3 ARROWS ON POT. WIPERS INDICATE DIRECTION OF CLOCKWISE ROTATION.

4 SCHEMATIC IS SUBJECT TO CHANGE WITHOUT NOTICE.

 CIRCUIT COMMON

 CHASSIS CONNECTION